



A New 60-Cycle Per Revolution Generator for Precision Tachometry Measurements

THE new -hp- Model 508A Tachometer Generator is designed to be used with the -hp- Model 522 Electronic Counter to make rapid, high-precision measurements of rotary speeds. For each revolution of its driving shaft, the generator provides 60 cycles of output voltage. This speed multiplication feature enables the combination of counter and generator to make in 1 second precision tachometry measurements that are direct-reading in revolutions per minute. The speed and accuracy obtainable with the generator and counter also make them valuable for a number of other studies of mechanical motion besides simple measurements of rpm.

SEE ALSO:
"Time-Frequency
Transform Table"
on inside pages

Fig. 2 indicates how the generator is used

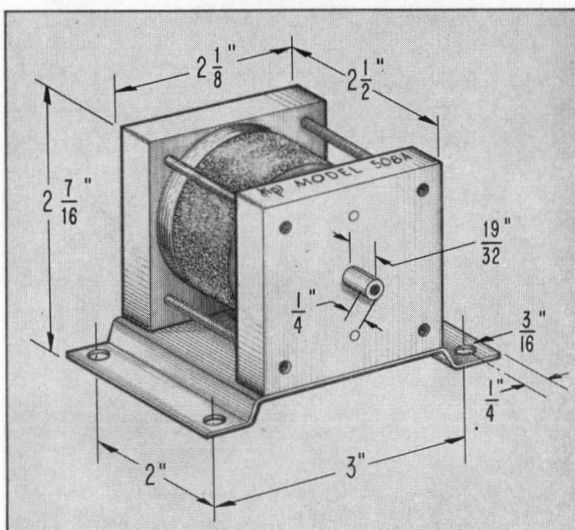

Fig. 1. New -hp- Model 508A Tachometer Generator produces 60 cycles of voltage for each revolution of its shaft. When used with the -hp- 522 Electronic Counter, precision rpm measurements can be made in 1 second. A 100-cycle model is also available.

in one of its major applications: quick production-line checking of slip in electric motors. The generator output terminal is connected to the 522 counter, which is set for a 1-second frequency measurement¹. The generator shaft is connected to the shaft of the production motor, either directly or through a test load or similar arrangement. The counter then automatically displays in digital form the rpm of the motor. A panel control on the counter allows the operator to select the length of time that the counter displays its measurement. At the end of this time the counter automatically repeats its measurement which requires 1 second. Measurements can thus be made as often as desired.

Rpm measurements made with the generator and counter are made to a high order of accuracy: within ± 1 rpm². If higher accuracy is desired, the measurement can be made for a 10-second instead of 1-second interval, in which case an accuracy of ± 0.1 rpm $\pm 0.001\%$ is obtained. These accuracies are achieved even by non-technical personnel, because the -hp- 522 presents the measured speed in digital form and because no operating adjustments are necessary.

Basically, the generator consists of an alnico magnet arranged in a closed magnetic loop which is interrupted when the generator shaft is turned. A pick-up coil couples the induced voltage to a coaxial type output connector. The closed-loop design enables

(Continued on back page)

¹The -hp- 522 Electronic Counter measures frequency by counting the number of cycles of the signal voltage that occur in an accurately-determined time interval such as 0.1, 1, or 10 seconds. See Hewlett-Packard Journal, Vol. 4, No. 3, and Vol. 5, No. 1-2. Copies available on request.

²This neglects the 522 gate-time inaccuracy which is insignificant at all but the highest rpm's.

TABLE OF IMPORTANT TRANSFORMS

In network design and analysis it is useful to have a graphic representation of common time functions and their corresponding transforms (frequency spectra). While extensive tables of function-transform pairs exist (e.g., Campbell and Foster, *Fourier Transforms For Practical Ap-*





plications), no convenient short illustrated table appears in the literature as far as can be determined. Such a table has been prepared by B. M. Oliver, *HP- Director of Research*, and is reproduced below.

A feature of the table is that it includes a plot of the frequency functions on Log

limit approached by functions 1, 3, 6, 7, 8, 9, or 10 as τ approaches 0 (α approaches infinity).

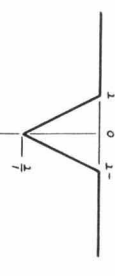
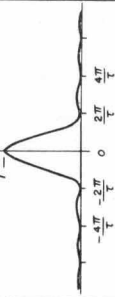
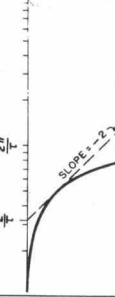
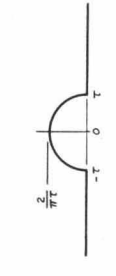
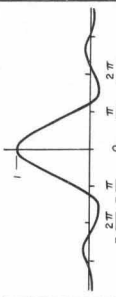
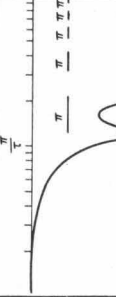
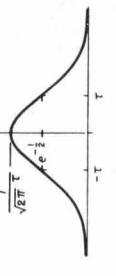
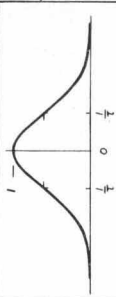
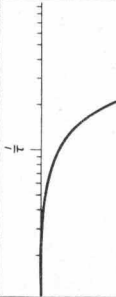
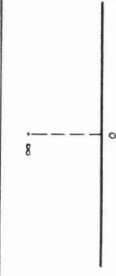
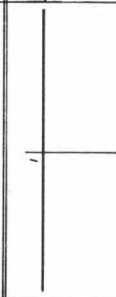
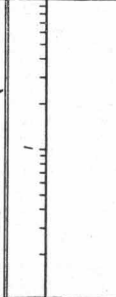
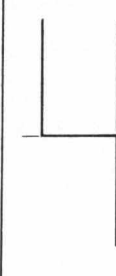
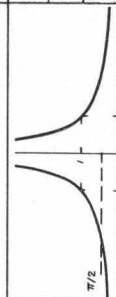
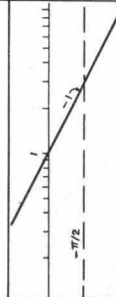
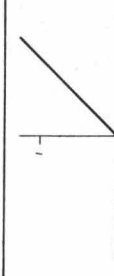
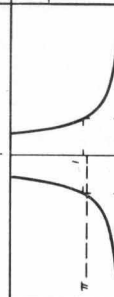
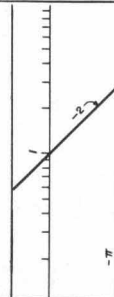
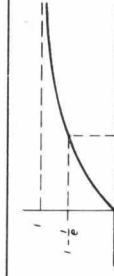
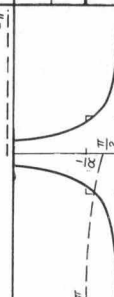
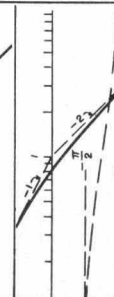
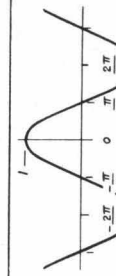
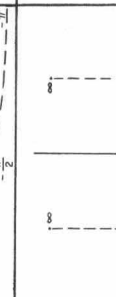
Reprints of this table will be available on request in a form suitable for wall or desk use. Please allow several weeks for replies to be compiled and printing completed.

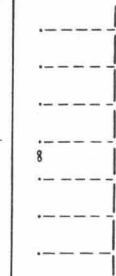
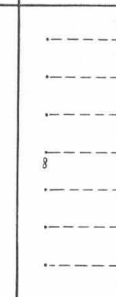
TIME FUNCTIONS		NO.	FREQUENCY FUNCTIONS	
			(LINEAR SCALES)	(LOG AMPL - LOG FREQ)
	$f(t) = \begin{cases} 0, & t < 0 \\ \alpha e^{-\alpha t}, & t > 0 \end{cases}$	1	$F(p) = \frac{\alpha}{p + \alpha}$ $F(\omega) = \frac{\alpha}{\alpha + i\omega}$	
	$f(t) = \begin{cases} 0, & t < 0 \\ \alpha^2 t e^{-\alpha t}, & t > 0 \end{cases}$	2	$F(p) = \frac{\alpha^2}{(p + \alpha)^2}$ $F(\omega) = \frac{\alpha^2}{(\alpha + i\omega)^2}$	
	$f(t) = \frac{\alpha}{2} e^{-\alpha t }$	3	$F(p) = \frac{\alpha^2}{\alpha^2 - p^2}$ $F(\omega) = \frac{\alpha^2}{\alpha^2 + \omega^2}$	
	$f(t) = \begin{cases} 0, & t < 0 \\ e^{-\alpha t} \sin \beta t, & t > 0 \end{cases}$	4	$F(p) = \frac{\beta}{(p + \alpha)^2 + \beta^2}$ $F(\omega) = \frac{\beta}{(\alpha^2 + \beta^2 - \omega^2) - i\omega^2 + i2\alpha\omega}$	
	$f(t) = \begin{cases} 0, & t < 0 \\ e^{-\alpha t} \cos \beta t, & t > 0 \end{cases}$	5	$F(p) = \frac{p}{(p + \alpha)^2 + \beta^2}$ $F(\omega) = \frac{i\omega}{(\alpha^2 + \beta^2 - \omega^2) - i\omega^2 + i2\alpha\omega}$	
	$f(t) = \frac{1}{\tau} \sin\left(\frac{\pi t}{\tau}\right)$	6	$F(\omega) = \begin{cases} 1, & \omega < \frac{\pi}{\tau} \\ 0, & \omega > \frac{\pi}{\tau} \end{cases}$	
	$f(t) = \begin{cases} \frac{1}{\tau}, & t < \frac{\tau}{2} \\ 0, & t > \frac{\tau}{2} \end{cases}$	7	$F(\omega) = \frac{\sin(\frac{\omega\tau}{2})}{(\frac{\omega\tau}{2})}$	

	$f(t) = \begin{cases} \frac{1}{\tau} - \frac{ t }{\tau}, & t < \tau \\ 0, & t > \tau \end{cases}$	8	$F(\omega) = \frac{\sin^2(\frac{\omega\tau}{2})}{(\frac{\omega\tau}{2})^2}$		
	$f(t) = \begin{cases} \frac{2}{\pi\tau} \sqrt{1 - (\frac{t}{\tau})^2}, & t < \tau \\ 0, & t > \tau \end{cases}$	9	$F(\omega) = \frac{2J_1(\omega\tau)}{\omega\tau}$		
	$f(t) = \frac{1}{\tau\sqrt{2\pi}} e^{-\frac{1}{2}(\frac{t}{\tau})^2}$	10	$F(\omega) = e^{-\frac{1}{2}(\tau\omega)^2}$		
	$f(t) = \lim_{\tau \rightarrow 0} \begin{cases} \frac{1}{\tau}, & t < \frac{\tau}{2} \\ 0, & t > \frac{\tau}{2} \end{cases} = \delta(t) \text{ (DELTA FUNCTION)}$	1S	$F(p) = F(\omega) = 1$		
	$f(t) = \int_{-\infty}^t \delta(\lambda) d\lambda = \begin{cases} 0, & t < 0 \\ 1, & t > 0 \end{cases} = u(t) \text{ (UNIT STEP)}$	2S	$F(p) = \frac{1}{p}$		
	$f(t) = \int_{-\infty}^t u(\lambda) d\lambda = \begin{cases} 0, & t < 0 \\ t, & t > 0 \end{cases} = s(t) \text{ (UNIT SLOPE)}$	3S	$F(p) = \frac{1}{p^2}$		
	$f(t) = \begin{cases} 0, & t < 0 \\ 1 - e^{-\alpha t}, & t > 0 \end{cases}$	4S	$F(p) = \frac{\alpha}{p(p+\alpha)}$		
	$f(t) = \cos \omega_0 t$	5S	$F(\omega) = \frac{\delta(\omega + \omega_0) - \delta(\omega - \omega_0)}{2}$		
	$f(t) = \sum_{-\infty}^{\infty} \delta(t - n\tau)$	6S	$F(\omega) = \sum_{-\infty}^{\infty} \delta(\omega - n\frac{2\pi}{\tau})$		

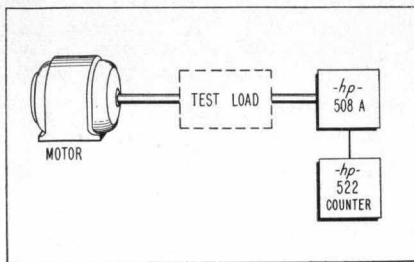

Fig. 2. Arrangement for measuring motor speed using tachometer generator and electronic counter.

the generator to be used in the presence of relatively strong external fields without affecting measurements.

Speed-wise, the generator can be used over a range from 15 rpm up to a rated maximum of 40,000 rpm. Fig. 3 shows the output voltage delivered by the generator over this range to the 522 counter³. The generator's open-circuit voltage is approximately 3 times that shown in Fig. 3.

Physically, the generator is small (Fig. 1) and weighs only 1½ pounds. The rotor is ground on all diameters and mounted in permanently-lubricated ball bearings. Details of the coupling shaft are given in Fig. 1. Either clockwise or counter-clockwise rotation can be used.

Because of its low driving torque, the 508A can be used with all but small energy devices without constituting a significant load. At 200 rpm the required driving torque is approximately ¼ in.-oz., and at 1500 rpm it is approximately ½ in.-oz.

Besides measuring rpm, the generator has many uses in studying non-

³In early production models the input sensitivity of the Model 522B for frequency measurements was 2 volts peak instead of 0.2 volt rms indicated in Fig. 3.

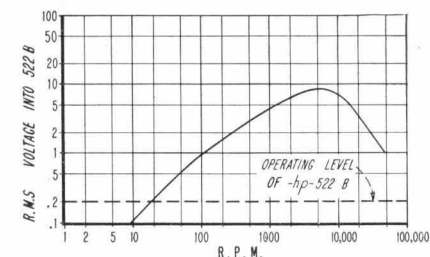

Fig. 3. Typical voltage characteristic of -hp-508A when used with -hp-522 counter. Generator open-circuit voltage is approximately three times that shown above.

periodic motion as well as periodic motion that may have torsional vibration and other effects. In such applications it is customary to connect the generator's output voltage to an oscilloscope and, at least where non-periodic motion is involved, to photograph the oscilloscope presentation for analysis and record purposes.

An interesting study of this type is indicated in the oscillogram of Fig. 4 which illustrates the output of the generator when used to investigate "screech" in a mechanical drive shaft. Close examination of the oscillogram shows that the shaft had discrete breaks in its speed of rotation as indicated by the dots in the center portion of Fig. 4. Since the generator produces 60 cycles of voltage per mechanical revolution of its shaft, each voltage cycle corresponds to 6 degrees of mechanical rotation of the shaft under test. By using this information and by establishing a suitable reference, it was easy to isolate for further investigation the region of rotation at which the screech occurred.

Another interesting oscillogram obtained with the generator—a detailed study of a Geneva intermittent motion—appears in Fig. 5. Such a motion mechanically divides one rotation into desired fractions of a rotation. The oscillogram illustrates the mechanical vibrations that occur and further gives an indication of the instantaneous velocity of the motion by the amplitude of the individual voltage cycles. The time interval depicted in Fig. 5 is approximately 1/30 second.

Valuable information can also be obtained with the generator concerning torsional vibration, speed variations, accelerating and decelerating characteristics, and so on.

100 CYCLE MODEL

The generator has also been designed in a model that provides 100 cycles per revolution instead of the 60 cycles provided by the 508A. In

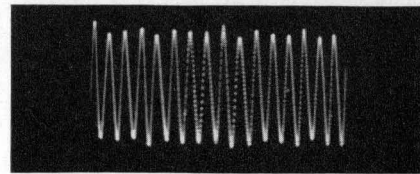

Fig. 4. Oscillogram obtained when using generator to investigate screeching shaft. Screech vibrations are evidenced by breaks in otherwise continuous waveform.

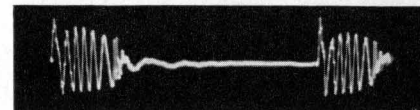

Fig. 5. Oscillogram obtained using generator with Geneva intermittent motion. Large initial voltage peaks indicate design is deficient since theoretically the starting velocity should be low.

general, measurements with this model, the 508B, are made as described above, except that the reading presented by the counter would be in units of revolutions per hundred seconds. The 508B, in combination with an oscilloscope, is also useful in obtaining higher definition of mechanical motion than is obtained with the 60-cycle model. Price and general specifications for the two models are the same, except that the voltage curve shown in Fig. 3 for the 508A is displaced to the left for the 508B.

—Wm. Girdner

SPECIFICATIONS -hp- MODEL 508A TACHOMETER GENERATOR

SPEED RANGE: 15 rpm to 40,000 rpm.
GENERATED OUTPUT: Sixty cycles for each shaft revolution.
OUTPUT VOLTAGE: Sufficient to operate -hp-522 Frequency Counter over range from 50 rpm to 40,000 rpm (see Fig. 3). Supplied at a coaxial type jack (UG-185/U).
DRIVING TORQUE: Approx. ¼ in.-oz. at 200 rpm.; ½ in.-oz. at 1500 rpm.
PEAK STARTING TORQUE: Approx. 4 in.-oz.
SHAFT DIMENSIONS: ¼" diam.; available length, approx. 9/16" (see Fig. 1).
MOUNTING DIMENSIONS: Four 3/16" diam. holes on 2" x 3" mtg/c.
OVERALL DIMENSIONS: 3⅞" w x 2½" h x 2½" d overall.
WEIGHT: Approx. 1.6 lbs.; shipping wt., approx. 3 lbs.
ACCESSORIES SUPPLIED: One 4-foot cable with coaxial type plugs (UG-88/U) at each end.
PRICE: \$75.00 f.o.b. Palo Alto, California.

-hp- MODEL 508B TACHOMETER GENERATOR

Price and specifications same as -hp- Model 508A except generates 100 cycles for each revolution. Output voltage characteristic is similar to that of 508A except peak occurs at lower frequency.

Data subject to change without notice.